

5000.1012K2M Low Profile DATA SHEET



KIT CONTAINS

WALL MOUNTED DRAIN
WITH GLASSLINE
LOW PROFILE OUTLET
HIGHLINE CUSTOM

5002.1012 | 5003.1012 Glassline Module

For right-aligned shower screen

For left-aligned shower screen



ITEM NUMBER R

5002.1012

ITEM NUMBER L

5003.1012

Specifications

MATERIAL	SURFACE	FLOORING
1,5 mm stainless steel (AISI 304)	Pickled	Tiles
MEMBRANE	FLOOR CONSTRUCTION	INSTALLATION WIDTH (A)
Liquid or sheet membrane	Concrete/wood	1001 mm
INSTALLATION DEPTH (B)	CENTRE (C)	SHOWER SCREEN SIZE (D)
1301 mm	501 mm	1200 mm



1417.0050 - Low Profile Outlet

Linear 1417.0050

Ø 50 mm horizontal drain

The odour barrier can be removed for cleaning

Can be rotated 180 degrees if a rear-facing outlet is required

Note: Odour barrier is VA-approved



Specifications

ITEM NUMBER	GTIN NUMBER	WEIGHT INCLUDING PACKAGING
1417.0050	5707692007915	500 g
WEIGHT EXCLUDING PACKAGING	MATERIAL	USAGE
350 g	Plastic (PP)	Line drain
BARRIER	GASKET	CAPACITY
With (odour barrier)	EPDM	0.6 l/s
SIDE INLET	CENTER	FITS DRAIN UNIT
Without	30 mm	1001, 1002, 1003, 1004, 1100, 3002, 3004, 5002, 5003, 4004

FITTING HEIGHTS - LINE FAUCETS 1001, 1002, 1003, 1004

Ø	Outlet direction	300	600	700	800	900	1000	1200
Ø 50 mm	Horizontal	64 mm	68 mm	69 mm	70 mm	71 mm	72 mm	74 mm

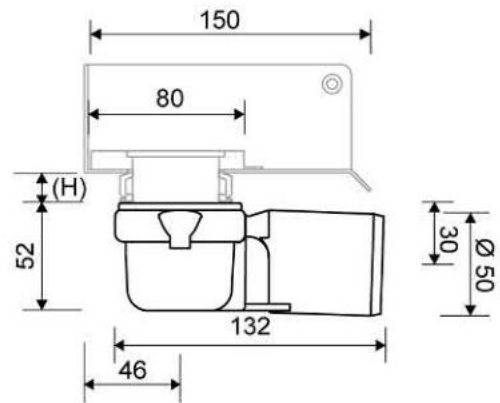

1950.1000 - 1000mm Drain Body

HighLine | Custom

The set consists of a Highline Custom base to place tile onto, heightener set and screws.
 Tile can overhang the Highline Custom to achieve a larger visual length.
 Consult with tile manufacturer for strength of tile and maximum overhang.
 Must be assembled before mounting.



Specifications

ITEM NUMBER	GTIN NUMBER	WEIGHT INCLUDING PACKAGING
1950.1000	5707692005362	2310 g
WEIGHT EXCLUDING PACKAGING	MATERIAL	USAGE
2190 g	Stainless steel (AISI 304)	Line drain
SURFACE	LENGTH MODEL	HEIGHTENER SET
Brushed	1000 mm	Plastic (PE)
LENGTH WITH/WITHOUT FRAME		
933/955 mm		

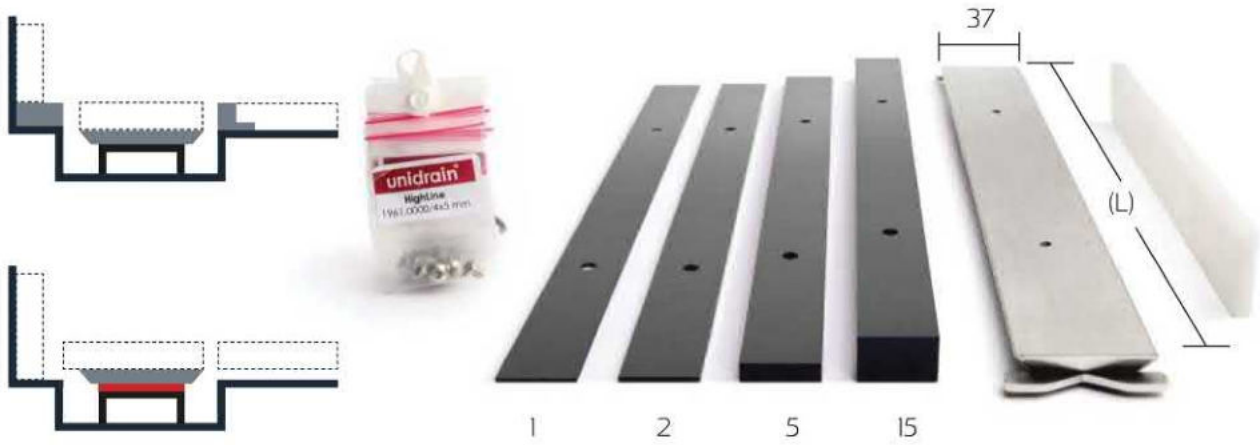

1950.1000

5100.1200

GlassLine | Right and left-aligned shower screen

Design: Transparent

10 mm safety glass

No visible screws or fittings in the finished result

The glass surface is treated with Cleantec nanotechnology, making it water-repellent, less susceptible to limescale and easier to clean.



Specifications

ITEM NUMBER	LENGTH MODEL	HEIGHT (H)
5100.1200	1200 mm	2104 mm
DESIGN	MATERIAL	
Transparent	Stainless steel (AISI 304) 10 mm safety float glass	

